

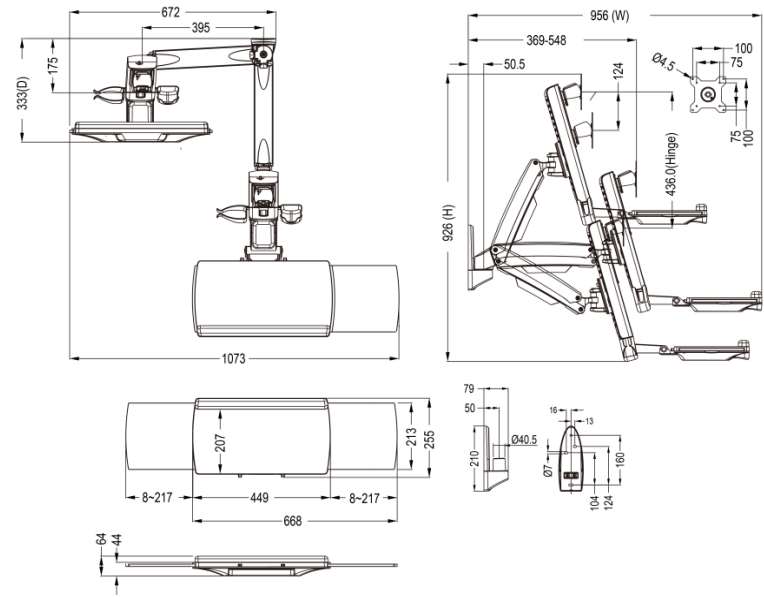

Highgrade
<http://www.highgrade.com.tw>

Model Name:ORW10
Issus Date:2019/07/22(E)

Complete System		
Net Weight	9.26 kg (20.42lbs)	
Dimension(W*H*D)	956 x 926 x 333 mm (37.64" x 36.46" x 13.11")	
Screw Type	M4	
Material	Steel/Plastic/Aluminum	
Display System		
Hinge Module	Swivel(Hinge)	+/-90°
	Tilt(Hinge)	-5° ~ + 35°
	Tilt(Keyboard)	0 ~ 90°
	Pivot	360°
	User Torque Adjust	Available
Display Support	Mounting Pattern	100x100 / 75x75 mm
	Display Type	Singal Monitor
	Panel Size Support	≤ 27"
	Support Weight (Arm)	2~8kg(4.4~17.6lbs)
	Support Weight (Keyboard)	2.5kg(5.5lbs)
Height Adjust	Height Adjustment Range (Display & KeyBoard Tray) / (Arm)	124mm(4.88") / 436mm(17.27")
	Tension Torque Adjust	Yes
	Tilt(Arm)	- 30° ~ + 65°
Max.Working Space	449 x 207 mm (17.68" X 8.15") for Keyboard Tray	
Extended Arm Provided	1	
Cable Management	Yes	



Screen	VESA	Tilt	Rotate	Swivel	Cable Management	Height Adjust	Torque Adjust